

▼ l'originale

 Made in Italy
EMC/2006/95/CE



Trasponder 1 ingresso + uscita Triac 230Vca

- Lunghezza massima del contatto in ingresso: 50cm
- Ingresso zona
- Ingresso 24h
- Connessione su linea MPX
- Tensione nominale di alimentazione: 12V
- Assorbimento massimo: 5mA
- Uscita Triac: max 1A@230Vca
- Grado di sicurezza : 1
- Classe ambientale : 2
- Dimensioni (LxAxP): 16x11x72mm
- Conforme alla norma CEI EN 50131-1

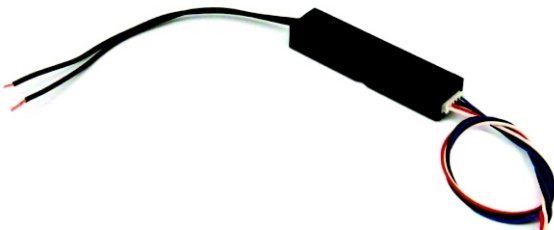

Programmazione

La seguente tabella illustra quali sono le funzionalità principali del Tipo12 (T12)

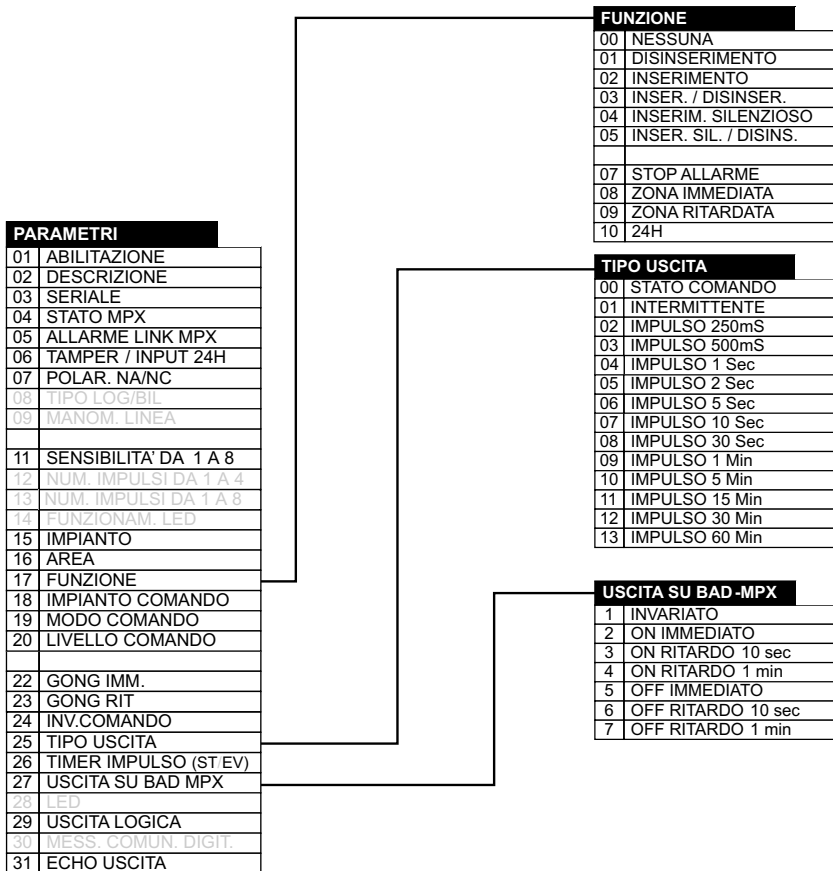

Installazione

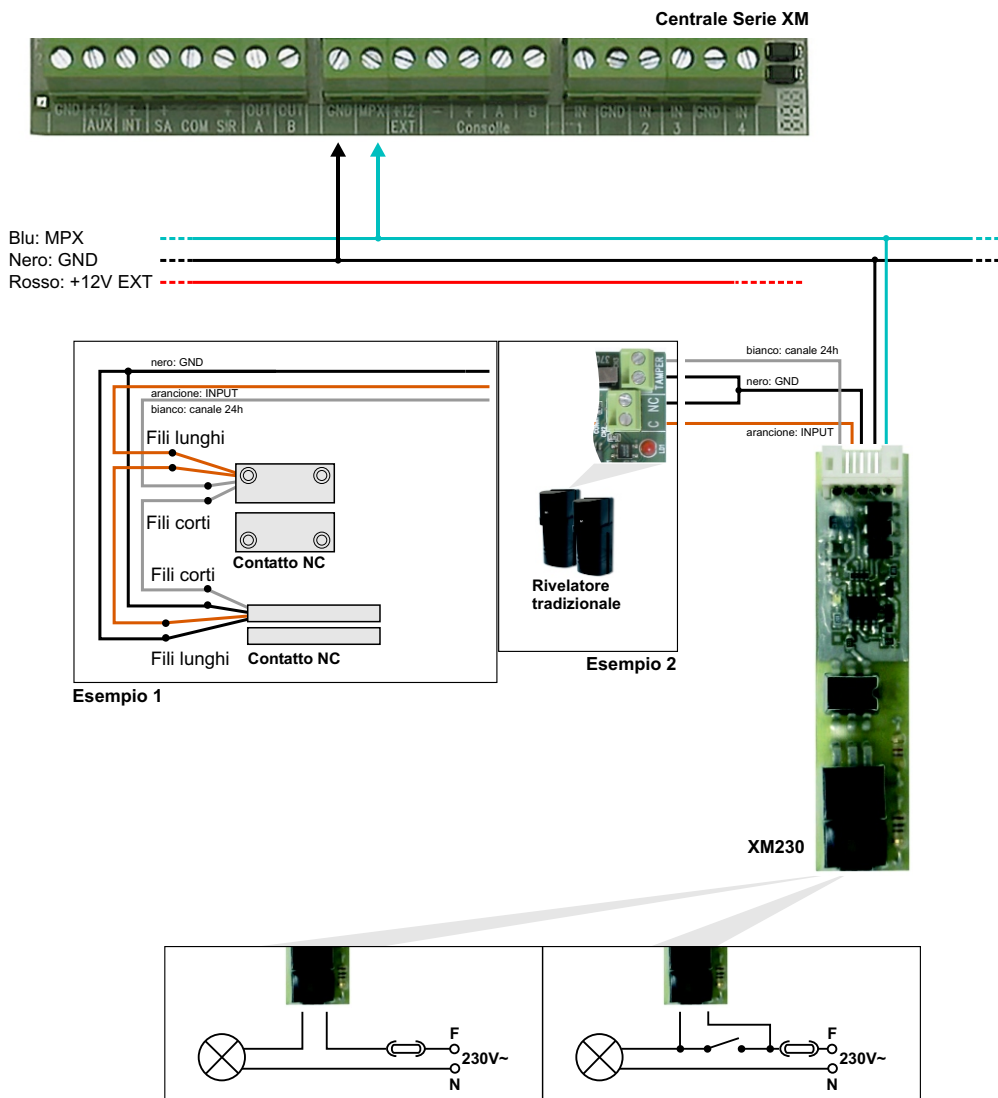

NOTA: Non installare il trasponder ad una distanza superiore ai 2mt dall'apparecchio utilizzatore (es. contatti, rivelatori, sensori etc.).



Transponder MPX 1 IN and 1 OUT with Triac 230V XM Series

- Maximum distance of input cable: 50cm
- Input Area
- 24h input
- Connection on MPX bus line
- Power supply voltage:12V
- Max current consumption: 5mA
- Triac output: max 1A@230Vca
- Safety degree : 1
- Ambiental class : 2
- Dimensions (WxHxD):16x11x72mm
- Accordance with standards CEI EN 50131-1

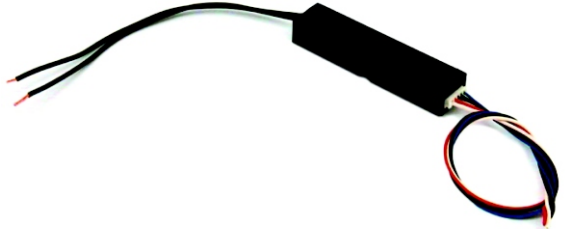

Programmation

The following table, shows what are the major features of the Type 12 (T12)

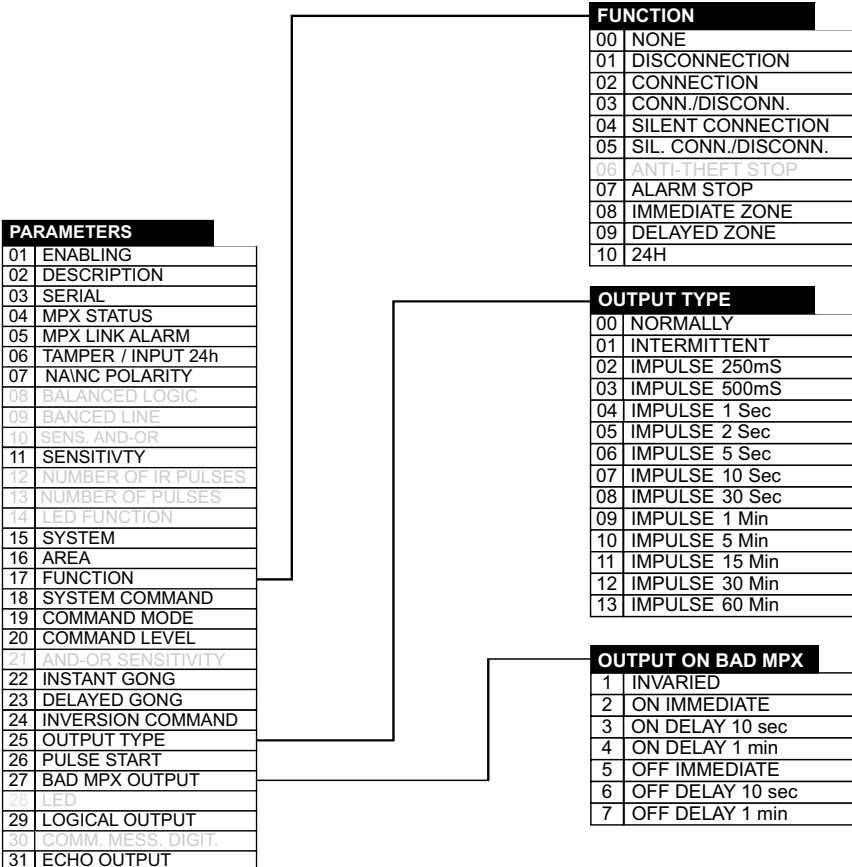

Installation

Serie XM central unit



Blue: MPX
Black: GND
Red: +12V EXT

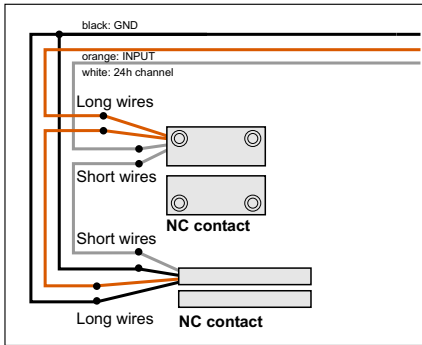

Example 1

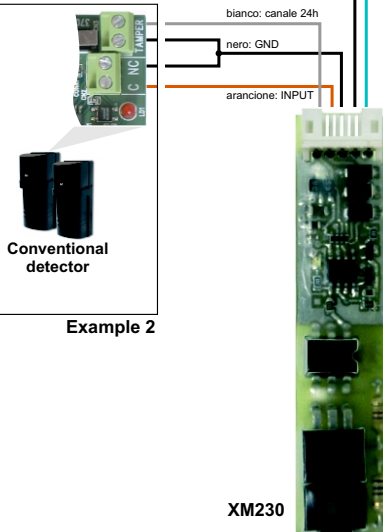

Example 2

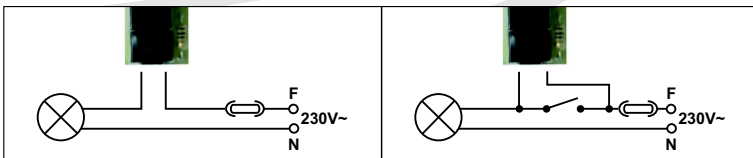

NOTE: Do not install the transponder at a distance exceeding the 2mt safekeeping (example contacts, detectors, sensors, etc.).